



■ Description

The actuator series AVGO15 has been designed to control the screwed globe valves series VGI up to DN50. The actuator is equipped by a bidirectional synchronous motor at 1500 N and available in ON-OFF, floating, proportional and Modbus (RS485) version. Fast and easy assembly. The actuator is equipped, for the proportional version, with a button for self-adjustment.

■ Technical specifications

Power supply	See schedule
Electrical connection	Screw terminal
Torque	1500 N
Max. stroke	22 mm
Running time	See schedule
Materials	ABS cover, self-extinguishing, aluminum body
Protection degree	IP54
Protection class	III 24 V AC/DC, I 230 V AC, ±10%
Working range °C	0...+50°C
Storage temperature and humidity	-25...+50°C, 5...95% RH, non-condensing
Fluid temperature	< 130°C
Maintenance	Free



Models	Action	Supply	Consumption	Running time
AVGO15 AVGO15B	on-off, floating	24 V AC/DC 230 V AC, ±10%	5,5 VA	1,5 s/mm or 3,8 s/mm
AVGO15M AVGO15BM	proportional	24 V AC/DC 230 V AC, ±10%	7,5 VA	1,5 s/mm or 3,8 s/mm

Suffix: **S** for 2x SPDT microswitches (excluding modulating version)

MOD Only for proportional models. Actuators with RS485 (RTU) control also include built-in analog control capability. The control mode, either Modbus RS485 RTU or analog, can be selected via RS485 (RTU) communication commands. When RS485 control is active, the analog input is disabled, while the analog output remains functional.



Electrical wiring

1 - AVGO15M... proportional version

AVGO15M

(power supply 24 V AC/DC)

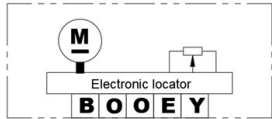

B	System potential 24 V	~ +
O	System neutral 0 V	~ -
O	Signal neutral (-)	~ + -
E	Positioning signal (+)	⏚
Y	Position feedback (+)	⏚

Wiring: max. 1.5 mm²

AVGO15BM

(power supply 230 V AC)

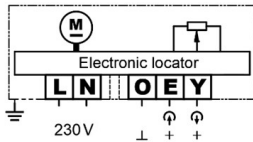

L	System potential 230 V	~ +
N	System neutral 0 V	~ -
O	Signal neutral (-)	~ + -
E	Positioning signal (+)	⏚
Y	Position feedback (+)	⏚

Wiring: max. 1.5 mm²

AVGO15M/MOD, modbus RS485

(power supply 24 V AC/DC)

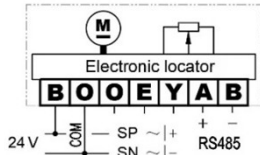

B	System potential 24 V	~ +
O	System neutral 0 V	~ -
O	Signal neutral (-)	~ + -
E	Positioning signal (+)	⏚
Y	Position feedback (+)	⏚
A	485 Forward signal input (+)	
B	485 Reverse signal input (-)	

Wiring: max. 1.5 mm²

AVGO15BM/MOD, modbus RS485

(power supply 230 V AC)

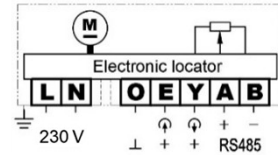

L	System potential 230 V	~ +
N	System neutral 0 V	~ -
O	Signal neutral (-)	~ + -
E	Positioning signal (+)	⏚
Y	Position feedback (+)	⏚
A	485 Forward signal input (+)	
B	485 Reverse signal input (-)	

Wiring: max. 1.5 mm²

2 - AVGO15... on-off floating version

AVGO15

(power supply 24 V AC/DC)

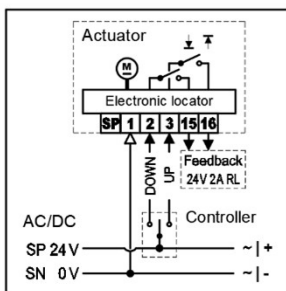

Optional: Connected as 3 wire

SP	System Potential 24V AC/DC	
1	System Neutral 0V AC/DC	
2	Stem extends ↓	Power Supply 24V AC/DC
3	Stem retracts ↑	
15	Bottom limit	Output Power Supply Max. 3A
16	Top limit	

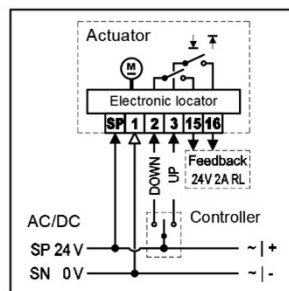

Optional: Connected as 4 wire

For Precise control and fast response in 3-point mode (0.02s)

Wiring: max. 1.5 mm²

AVGO15B

(power supply 230 V AC)

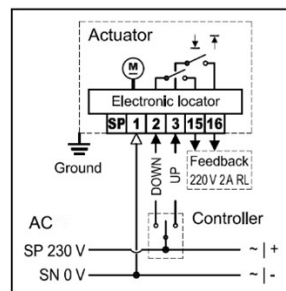

Optional: Connected as 3 wire

SP	System Potential 230 V AC	
1	System Neutral 0V AC	
2	Stem extends ↓	Power Supply 230 V AC
3	Stem retracts ↑	
15	Bottom limit	Output Power Supply Max. 3A
16	Top limit	

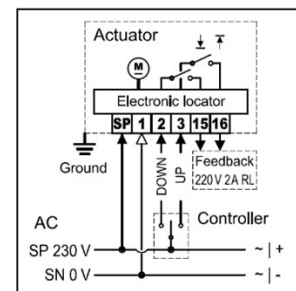

Optional: Connected as 4 wire

For Precise control and fast response in 3-point mode (0.02s)

Wiring: max. 1.5 mm²

Installation

As shown in the figure above, install the electric actuator onto the control valve body as follows:

Fig. 1 Using a suitable tool (pliers or a wrench), pull the valve stem out of the valve body to its highest position (1).

Fig. 2 Remove the U-bolt from the actuator and loosen the clamp on the actuator rod. Align the actuator rod with the valve stem (see Figure 2). Using a 5 mm Allen key, tighten the two screws securing the valve stem with a torque of 3.5–5.1 Nm (see Figure 3).

Fig. 3 Push the actuator downward until its bottom surface rests firmly on the valve body mounting surface (see Figure 4).

Fig. 4 As shown in Figures 5 and 6, insert the U-bolt into the mounting hole between the actuator and the valve body, then secure it with two M8 nuts (maximum torque: 16 Nm).

Fig. 5 Finally, slide the two indicator rings (one red and one blue) along the actuator bracket until they are positioned close to the pointer.

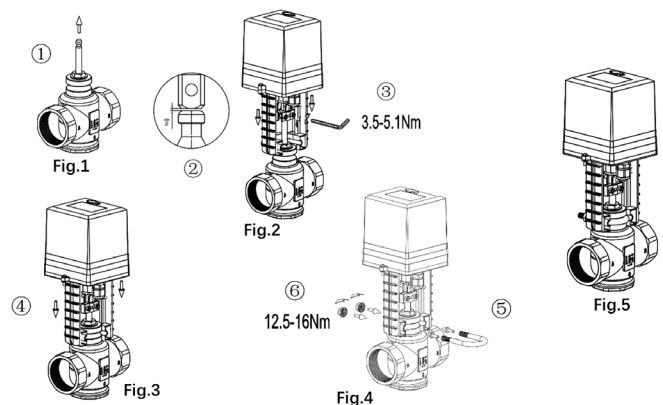



Setting AVGO15... ON/OFF, FLOATING

SW1 **DIP1:** FAST/SLOW – Speed selection
 FAST: AVGO15xx-1.5 s/mm
 SLOW: AVGO15xx-3,8 s/mm
DIP2: Undefined

The floating actuator is equipped with an electronic positioner, as shown in the figure beside:

1. Fully connect the actuator to the valve body

Install according to the diagram and the steps described in “Complete Machine Assembly”.

2. Correctly connect the power cable or control wiring

Perform wiring according to the “Wiring Diagram” included with the product.

3. Set the DIP switch to the required configuration

Adjust the DIP switch only after disconnecting the power supply.

4. Operate the actuator through the controller to perform a full run test

Once the test run is completed, the equipment commissioning is finished.

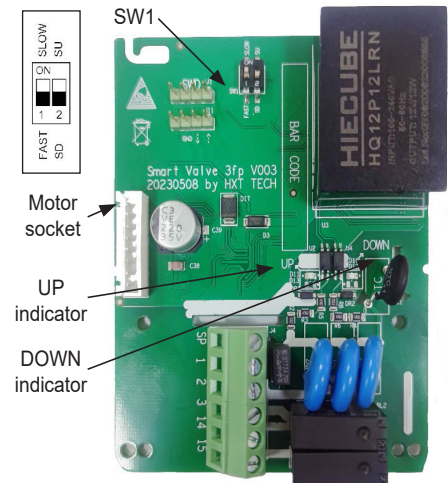

Setting AVGO15... PROPORTIONAL

DIP 1 – Feedback Signal Type

ON: DC current signal
OFF: DC voltage signal

DIP 2 – Input (Control) Signal Type

ON: DC current signal
OFF: DC voltage signal

DIP 3 – Positioner Action Mode (Direct / Reverse Acting)

OFF – Direct Acting: When the input signal increases, the actuator rod moves upward.

ON – Reverse Acting: When the input signal increases, the actuator rod moves downward.

DIP 4 & DIP 5 – Signal Loss Response Mode (Applicable only when the input signal is 4–20 mA or DC 2–10 V)

> When DIP 5 = OFF:

DIP 4 = ON: Upward fail-safe – on input signal loss, the actuator rod moves to the upper limit position.

DIP 4 = OFF: Downward fail-safe – on input signal loss, the actuator rod moves to the lower limit position.

> When DIP 5 = ON:

Position Hold – regardless of DIP 4, on input signal loss the actuator rod remains at its current position.

Note: This function is not available with DC 0–10 V or 0–20 mA input signals.

For these signal types, if the input signal is lost, the actuator defaults to operating according to the 0% signal level.

DIP 6 – Positioning Mode (Refer to the wiring diagram for system connections)

OFF: Modulating signal control mode

ON: 3-position control mode or manual control (manual operation possible using the mechanical handle)

DIP 7 – Starting Point of Input and Feedback Signals (0% / 20%)

OFF: 0% (e.g., DC 0–10 V, 0–20 mA)

ON: 20% (e.g., DC 2–10 V, 4–20 mA)

DIP 8 – Running Speed Selection

OFF: High-speed mode – 1.5 s/mm

ON: Low-speed mode – 3.8 s/mm

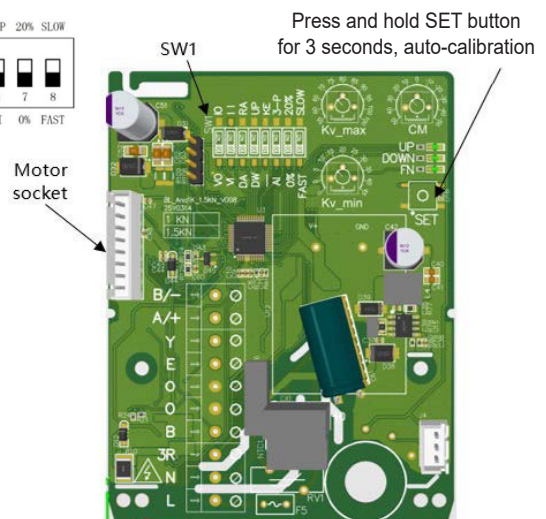
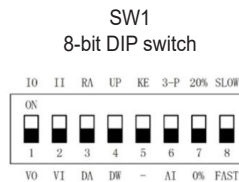



Content of the standard RS485 communication Modbus RTU protocol

1. Basic description of the agreement

No	Parameter name	Communication protocol stipulates
1	Working mode	Master-slave mode
2	baud rate	2400/4800/9600/19200 // Default: 9600
3	Byte format	No parity (default) / odd parity / even parity, 8-bit data bits, 1 stop bit
4	CRC check code	CRC-16 (Standard Modbus) 0x8005
5	CRC check method	CRC-16 (Standard Modbus)
6	Data frame interval	more than 3.5 bytes

2. Protocol format

2.1 Multiple register read - Function code: 0x03

Master to slave transmission format

Definition	Slave address	Function code	Starting address of the register		Register length		CRC16 checksum	
Bytes occupied	1	1	2		2		2	
Endianness	1	1	H	L	H	L	H	L

Device address (slave address): 0x01
Function code: 0x03 - Register reading

Starting register address: The starting address of the register to be read
Register length: The number of registers to be read

Slave to Master response format

Definition	Slave address	Function code	Num. of Bytes	The content of register 1		The content of register 2		The content of register N		CRC16 checksum	
Bytes occupied	1	1	1	2		2		2		2	
Endianness	1	1	1	H	L	H	L	H	L	H	L

Device address (slave address): 0x01
Function Code: 0x03 - Register Reading

Number of Bytes: Refers to the number of bytes contained in registers 1 to N
Contents of Registers 1 to N: The consecutive contents starting from the first address of the register and with a length equal to the register length N

2.2 Single Register Write - Function Code: 0x06

Master to slave transmission format

Definition	Slave address	Function code	Address of the register		The written content		CRC16 checksum	
Bytes occupied	1	1	2		2		2	
Endianness	1	1	H	L	H	L	H	L

Device address (slave address): 0x01
Function Code: 0x06 - Single Register Write

Register Address: Address of the register to be written
Register Content: Data content to be written

Slave to Master response format

Definition	Slave address	Function code	Address of the register		The written content		CRC16 checksum	
Bytes occupied	1	1	2		2		2	
Endianness	1	1	H	L	H	L	H	L

Device address (slave address): 0x01
Function Code: 0x06 - Single Register Write

Register Address: Address of the register to be written
Register Content: The written data content



2.3 Multiple register writing - Function code: 0x10

Master to slave transmission format

Definition	Slave address	Function code	Starting address of the register	Register length	Num. of Bytes	The content of register 1	The content of register 2	The content of register N	CRC16 checksum
Bytes occupied	1	1	2	2	1	2	2	2	2
Endianness	1	1	H L	H L	1	H L	H L	H L	H L

Device address (slave address): 0x01

Function Code: 0x10 - Multiple Register Write

Starting Register Address: The starting address of the register to be written

Register Length: The number of registers to be written

Number of Bytes: Refers to the number of bytes contained in registers 1 to N

Slave to Master response format

Definition	Slave address	Function code	Starting address of the register	Register length	CRC16 checksum
Bytes occupied	1	1	2	2	2
Endianness	1	1	H L	H L	H L

Slave address: 0x01

Function code: 0x10 - Multiple register write

Starting address of register: Starting address of the register to be written

Register length: Number of registers to be written

2.4 Custom function code: 0x45

-- Change communication address according to electronic serial number

Example of instructions:

Master to slave transmission format:

00 45 0beb ecf9 08 07 d3 // Set the slave address of the device with the electronic serial number 0x0BEB ECF0 (decimal 2 0001 1 001) to 0x08.

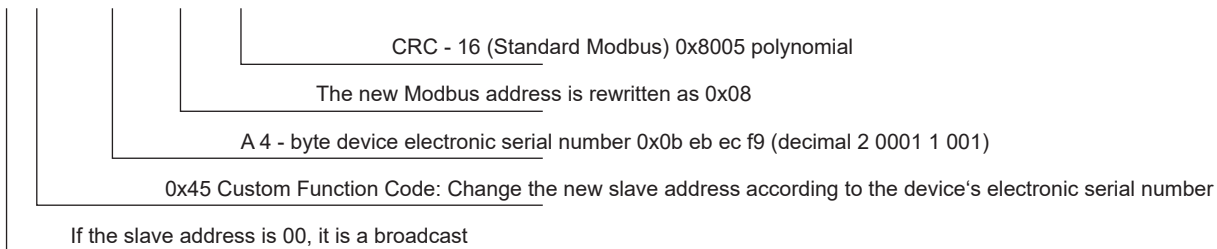

Slaves that meet the conditions update the address and reply to the information format:

08 45 0beb ecf9 08 8e 13 // The slave address of the device with the electronic serial number 0x0BEB ECF0 (decimal 2 0001 1 001) has been set to 0x08.

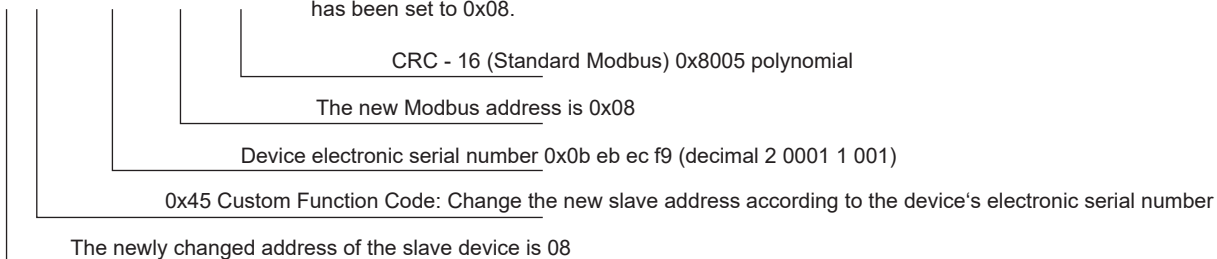



2.5 Custom function code: 0x41

-- Each slave device reports "electronic serial number + slave address" with a delay according to its electronic serial number

Example of instructions:

Master to slave transmission format:

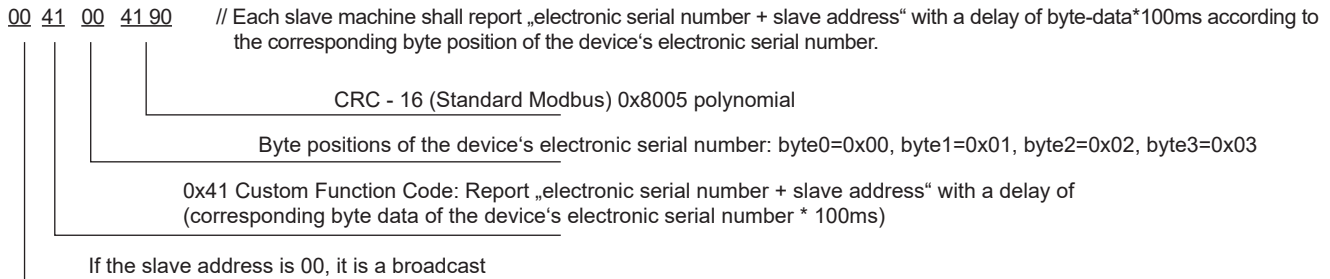

All slaves report "electronic serial number + slave address" with separate delayed reporting and reply to the information format:

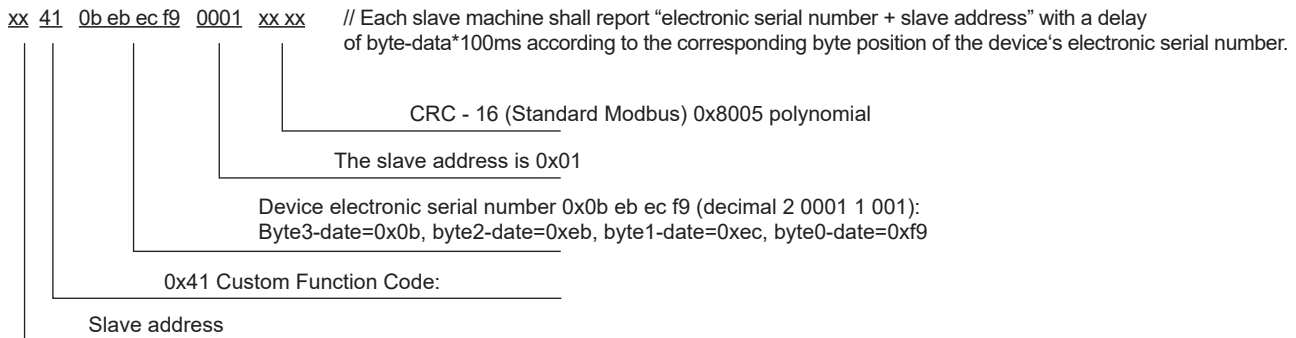

2. MODBUS-RTU Register Address Table

Read and write device configuration parameter information

Address	Function code	Register length	Variable name or meaning	Description	Remarks
0x0080	0x03/0x06	1	Communication configuration parameters	Bit15 Bit8 :0x00 (To be used) Bit7: 0 - 2 stop bits 1 - 1 stop bit (default) Bit6 - Bit5: 11 - odd parity 10 - even parity 01 - No verification (default) 00 - No verification Bit4 - Bit0: baud rate 00000 - 300bps 00001 - 600bps 00010 - 1200bps 00011 - 2400bps 00100 - 4800bps 00101 - 9600bps (default) 00110 - 19200bps 00111 - 115200bps	
0x0081 - 0 x 0082	0x03/0x06	2	Electronic Serial Number of this Device (Meter Number)	Factory default values, which users can modify by themselves. (Please note that the higher bits come first)	
0x0083	0x03/0x06	1	Slave address	Bit15-Bit8 :0x00 (To be used) Bit7-Bit0 : Slave address Default address 0x01, broadcast address 0x00, addresses can be set from 1 to 247	



Read device status information - a total of 3 registers

Address	Function code	Register length	Variable name or meaning	Description	Remarks
0x0208	0x03	1	Position feedback	0-1000 corresponds to 0-100.0%	
0x0209 - 0x020A	0x03	2	Fault code	Fault information is represented by bit status, where 0 indicates no fault and 1 indicates a fault. Except for the locked-rotor fault, other faults can only be cleared by powering on. Bit0: Upward locked-rotor (upward overload) Bit1: Downward locked-rotor (downward overload) Bit2: Upward stall alarm Bit3: Downward stall alarm Bit4: Upward fault alarm Bit5: Downward fault alarm Bit6: Potentiometer upper limit alarm Bit7: Potentiometer lower limit alarm Bit8: Signal loss alarm Bit9: Hardware failure Bit10: Self-calibration not completed Bit11: 0 Bit12: 0 Bit13: 0 Bit14: 0 Bit15: 0 Bit16: 0	

Example:

Reading device status information - Register start address: 0x0208, total of 3 (0x03) registers:

```
xx 03 0208 0003 xx // Command to read device status information
```

CRC - 16 (Standard Modbus) 0x8005 polynomial
 Slave address: such as 0x01, etc. (hexadecimal number)

Write a valve opening command

Address	Function code	Register length	Variable name or meaning	Description	Remarks
0x01FF	0x06	1	Set the valve position	0-1000 corresponds to 0-100.0%	Opening control with immediate command given applicable to all working conditions.

Example:

Write a device opening command - Register address: 0x01FF:

```
xx 06 01FF 01F4 xx // Set the valve opening to 50% (50% -> decimal 500 -> hexadecimal 0x01F4)
```

CRC - 16 (Standard Modbus) 0x8005 polynomial
 Slave address: such as 0x01, etc. (hexadecimal number)



Advanced Parameter Settings - Engineer Parameters

Address	Function code	Register length	Variable name or meaning	Description	Remarks
0x0404	0x06	1	Stroke self-calibration	Bit15-Bit1: reserved Bit0: Bit0=0 Disable Bit0=1 Enabled	
0x0405	0x06/0x03	1	Whether to enable the 485 function (not enabled by default)	0: Disable 1: Enabled	
0x0406	0x06	1	Input of the access password for the engineer parameter register	Default password 0x0531	When the password written in the instruction is the same as the default password, the engineering parameter writable mode will be activated. This mode remains active until a power outage occurs or a 2-hour timeout is reached.
0x0407-0x040F		9	Reserved		

■ Dimensions (mm)

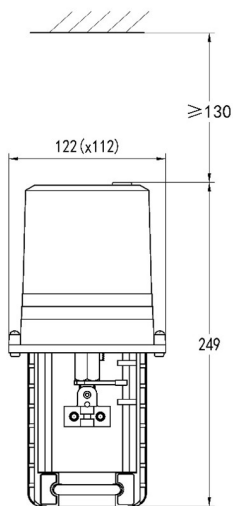

AVGO15...