



Description

The duct temperature/humidity transmitter serie KTD measures the temperature and humidity by capacitive sensors and converts the value into a linear output signal 0...10 VDC or 4...20 mA.

Technical specifications

Measurement range RH	0...100 % RH
Accuracy RH	2 % RH
Measurement range °C	0...50°C, 0...100°C, -30...+70°C, -40...+60°C
Accuracy °C	0,5°C
Power supply	24 VAC (±5%) 50-60 Hz / 15...35 VDC
Power consumption	< 2,5 W
Working resistance at 0...10 VDC	min. 1 kOhm
Working resistance at 4...20 mA	max 500 Ohm
Electrical connection	Screw terminals max. 1,5 mm ²
Housing	ABS
Dimensions	See drawing
Protection type	IP41
Working range RH	0...98% RH in contaminant-free, non-condensing air
Working temperature °C	-30...+80°C
Standards	CE conformity, RoHS



Order matrix

Model	Accuracy	Output 1 Humidity		Output 2 Temperature		Option	
KTD	2 %RH	0	no output	0	no output	M	Modbus
		1	0...10 V	1	0...10 V	D	Display
		2	2...10 V	2	2...10 V	R	Relay*
		3	0...5 V	3	0...5 V		
		4	1...5 V	4	1...5 V		
		5	4...20 mA	5	4...20 mA		

* The relay option is available only with display.

DIP Switch

DIP	Temp. Ranges	DIP	Response
	0...50°C		1 sec.
	0...100°C		5 sec.
	-30...+70°C		10 sec.
	-40...+60°C		30 sec.



Transmitter hardware

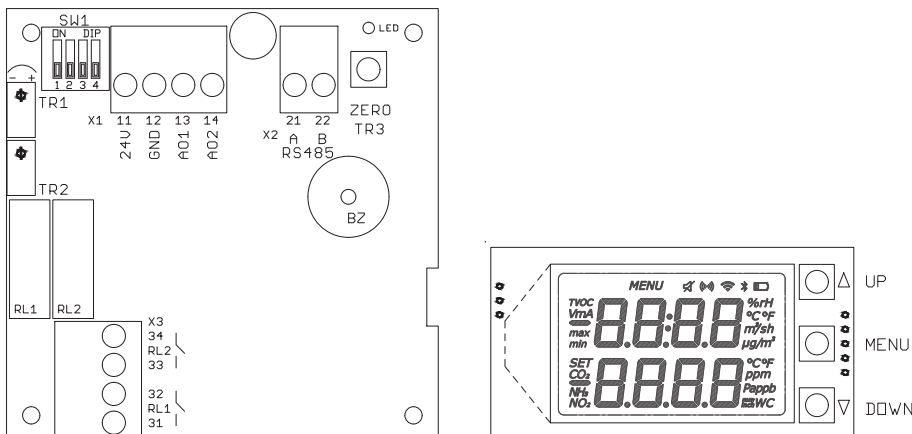

SW1 DIP Switch for configuration range and response time

X1 TERMINAL

11	24V	15...35 VDC or 24 VAC (± %5, 50-60 Hz)
12	GND	ground for power and reference for outputs
13	AO1	analog output 1
14	AO2	analog output 2

X2 TERMINAL

21	A / RS485	modbus communication positive pair
22	B / RS485	modbus communication negative pair

LED bead LED, periodically lights ON and OFF
modbus communication, blinks when there is a communication

TR1 not used
TR2 not used
ZERO / TR3 not used
RL1 relay 1
BZ buzzer

X3 TERMINAL

31	NO - RL1	relay 1 dry contact max. rating 1A @ 230 VAC
32	NO - RL1	relay 1 dry contact max. rating 1A @ 230 VAC

Electrical wirings

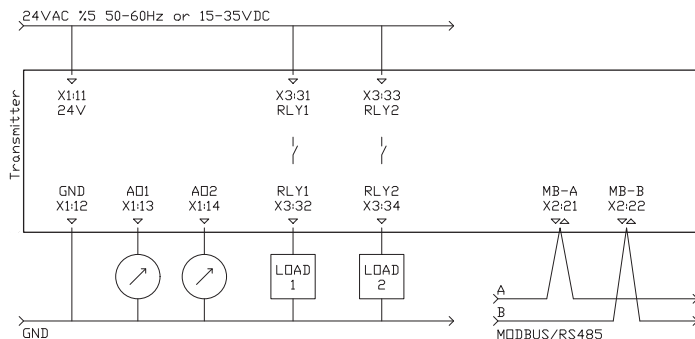

Relay contact rating is max. 1A at 230 VAC.
We kindly advise using 24 VAC for avoiding high voltage harmonics and external power relay for bigger loads.
Please use shielded and twisted paired cables for Modbus connections.



Display & Buttons

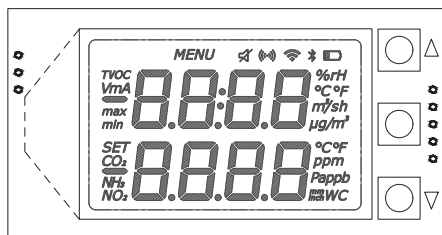

- UP press for increasing the value or choosing the next parameter
- MENU press and wait to enter MENU, click to navigate between sub menus one by one
- DOWN press for decreasing the value or choosing the previous parameter

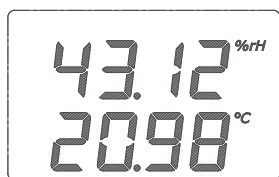

main screen
transmitter is working

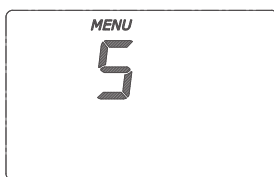

keep pressing MENU button until seeing 0
transmitter is not working in MENU mode

Parameters for Relay & Buzzer

Main Screen >>>> r1 L > r1 H > r1 A > Main Screen

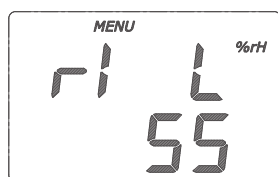

LOW set point for Relay

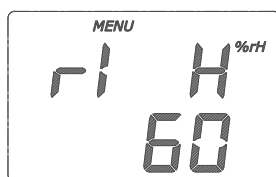

HIGH set point for Relay

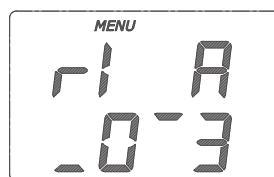

ACTION selection for Relay

Actions for Relay & Buzzer



action 0,
relay contact is always OPEN
buzzer is always SILENCE

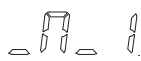

action 1,
relay contact is CLOSED between points, OPEN under LOWpoint and OPEN over HIGHpoint
buzzer is WARNING between points, SILENCE under LOWpoint and SILENCE over HIGHpoint



action 2,
relay contact is OPEN between points, CLOSED under LOWpoint and OPEN over HIGHpoint
buzzer is SILENCE between points, WARNING under LOWpoint and SILENCE over HIGHpoint

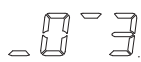

action 3,
relay contact is CLOSED over HIGHpoint, OPEN under LOWpoint, hysteresis between points
buzzer is WARNING over HIGHpoint, SILENCE under LOWpoint, hysteresis between points

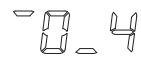

action 4,
relay contact is OPEN over HIGHpoint, CLOSED under LOWpoint, hysteresis between points
buzzer is SILENCE over HIGHpoint, WARNING under LOWpoint, hysteresis between points



ACTIONS	under LOW	between LOW & HIGH	over HIGH
0 : 0.0.0	Open	Open	Open
1 : 0.1.0	Open	Closed	Open
2 : 1.0.1	Closed	Open	Closed
3 : 0.X.1	Open	Hysteresis	Closed
4 : 1.X.0	Closed	Hysteresis	Open

0 : Relay Contact is OPEN, Buzzer is in Silent mode

1 : Relay Contact is CLOSED, Buzzer is in Warning mode

X : Relay Contact is at HYSTERESIS position, OPEN if previous position open, CLOSED if previous position closed

Modbus RS485 protocol

Default Settings: Modbus ID:1, 9600, 8bit, None, 1. Register Table starts from Base 1.

Use Function 3 for Reading and Function 6 for Writing Holding Registers. Whenever writing to any Modbus Parameter, new parameter is activated instantly and you should have to configure master device according to new parameters. For every reboot/initializing, Modbus is activated with default parameters for 3 seconds. After 3seconds, Modbus is reconfigured according your parameter settings.

Unlisted registers are for analog output calibrations and some system parameters. Please do not change unlisted registers.

Register	R/W	Range	Description
1	R & W	1...254	Modbus Address
2	R & W	0...4	Baudrate, 0: 9.600, 1: 19.200, 2: 38.400, 3: 57.600, 4: 115.200
3	R & W	0...3	Bit_Parity_Stop, 0: 8bit_None_1, 1: 8bit_None_2, 2: 8bit_Even_1, 3: 8bit_Odd_1
4	R		Humidity as %rH x10, divide by 10 for exact value
5	R		Temperature as C x10, divide by 10 for exact value
6	R	0 or 1	Relay 1, contact position, 0: OFF - Contact is Open, 1: ON - Contact is Closed
7	R	0...1.000	Relay 1, LOW point
8	R	0...1.000	Relay 1, HIGH point
9	R	0...4	Relay 1, ACTION
10	R	0 or 1	Relay 2, contact position, 0: OFF - Contact is Open, 1: ON - Contact is Closed
11	R	0...1.000	Relay 2, LOW point
12	R	0...1.000	Relay 2, HIGH point
13	R	0...4	Relay 2, ACTION
14	R	0 or 1	Buzzer, 0: OK-Silence, 1: PreAlarm - warning intermittently, 2: WARNING continuously
15	R	0...1.000	Buzzer, LOW point
16	R	0...1.000	Buzzer, HIGH point
17	R	0...4	Buzzer, ACTION
18-29	R		Only for service needs
30	R		Blank
31	R		Temperature as C x10, divide by 10 for exact value
32	R		Temperature as C
33	R		Temperature as F x10, divide by 10 for exact value
34	R		Temperature as F
35	R		Humidity as %RH x10, divide by 10 for exact value
36	R		Humidity as %RH



■ Dimensions (mm)

