



Description

The KSDC CO₂ sensor measures air quality through the presence of carbon dioxide in air ducts in the range between 0 and 10k ppm. The measurement of CO₂ concentration happens through a maintenance free NDIR sensor that operates on an infrared basis and which compensates the presence of any impurity. The product is provided different outputs.

Technical specifications

Measurement range CO₂	400...2000, 0...2k, 0...5k, 0...10k ppm selectable
Accuracy CO₂	± 70 ppm +3% reading
Accuracy temperature (*)	±0,3°C (5...60°C) + 1% FS
Accuracy humidity (*)	±2% RH (20...80%RH) + 2% FS
Power supply	24 VAC (±5%), 15...35 VDC
Consumption	< 2,5 W
Sensible element	NDIR self adjusting
Output	0...5 VDC, 0...10 VDC, 4...20 mA, Modbus 485
Electrical connection	Pluggable screw terminal for cables 1,5 mm ²
Protection type	IP41
Working range RH	10...95% RH in contaminant-free, non-condensing air
Working temperature °C	-30...+70°C
Storage temperature	-20...+50°C
Standards	CE conformity, RoHS



Order matrix

Model	Output 1 CO ₂	Output 2 Temperature	Output 3 Humidity	Option
KSDC	0 no output	0 no output	0 no output	M Modbus
	1 0...10 V	1 0...10 V	1 0...10 V	D Display
	2 2...10 V	2 2...10 V	2 2...10 V	R Relay*
	3 0...5 V	3 0...5 V	3 0...5 V	
	4 1...5 V	4 1...5 V	4 1...5 V	
	5 4...20 mA	5 4...20 mA	5 4...20 mA	

* The relay option is available only with display.

DIP Switch

DIP 1-2	CO2 Ranges	DIP 4	Response
	400-2.000 ppm		60 sec.
	0-2.000 ppm		20 sec.
	0-5.000 ppm		
	0-10.000 ppm		



Transmitter hardware

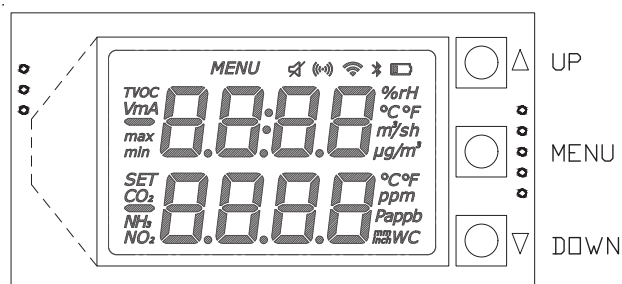
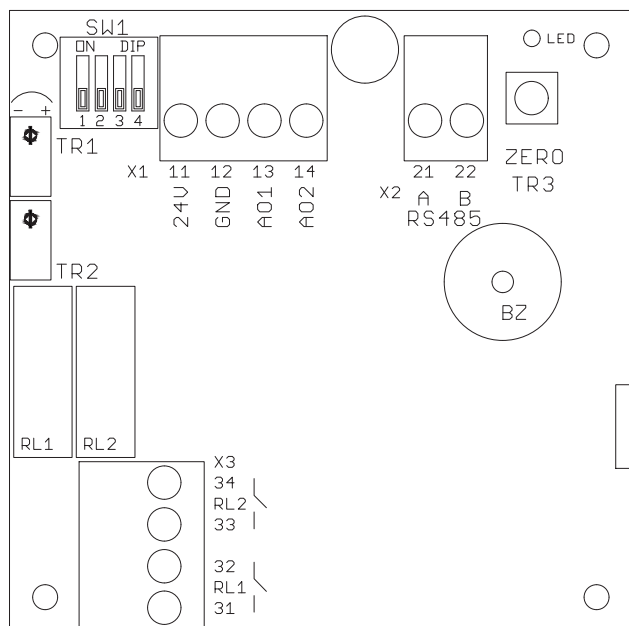

- SW1** DIP Switch for configuration range and response time
- X1 TERMINAL**
 - 11 24V 15...35 VDC or 24 VAC (± %5, 50-60 Hz)
 - 12 GND ground for power and reference for outputs
 - 13 AO1 analog output 1
 - 14 AO2 analog output 2
- X2 TERMINAL**
 - 21 A / RS485 modbus communication positive pair
 - 22 B / RS485 modbus communication negative pair
- LED** bead LED, periodically lights ON and OFF
modbus communication, blinks when there is a communication
- TR1** not used
- TR2** not used
- ZERO / TR3** not used
- RL1** relay 1
- BZ** buzzer
- X3 TERMINAL**
 - 31 NO - RL1 relay 1 dry contact max. rating 1A @ 230 VAC
 - 32 NO - RL1 relay 1 dry contact max. rating 1A @ 230 VAC

Electrical wirings

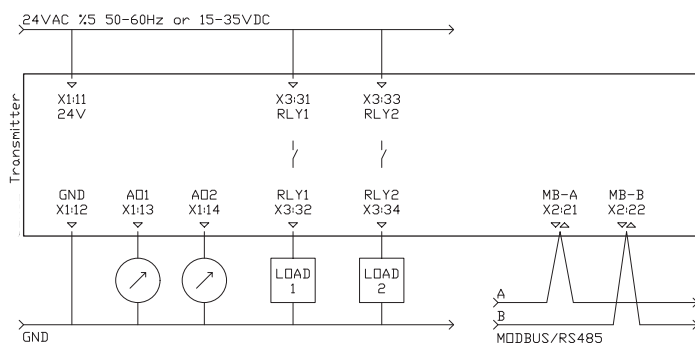



Relay contact rating is max. 1A at 230 VAC
 We kindly advise using 24V for avoiding high voltage harmonics
 and external power relay for bigger loads
 Please use shielded and twisted paired cables for Modbus
 connections

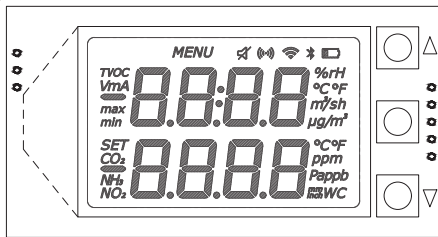

Display & Buttons



-  UP press for increasing the value or choosing the next parameter
-  MENU press and wait to enter MENU, click to navigate between sub menus one by one
-  DOWN press for decreasing the value or choosing the previous parameter



main screen
transmitter is working

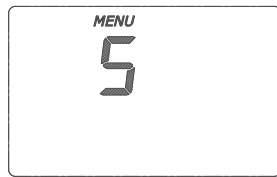

keep pressing MENU button until seeing 0
transmitter is not working in MENU mode

Parameters for Relay & Buzzer

Main Screen >>>> r1 L > r1 H > r1 A > Main Screen

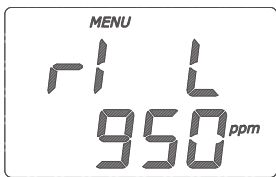

LOW set point for Relay

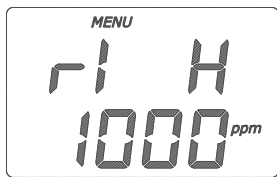

HIGH set point for Relay

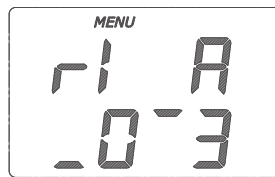

ACTION selection for Relay

Actions for Relay & Buzzer



action 0,
relay contact is always OPEN

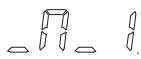

action 1,
relay contact is CLOSED between points, OPEN under LOWpoint and OPEN over HIGHpoint



action 2,
relay contact is OPEN between points, CLOSED under LOWpoint and OPEN over HIGHpoint

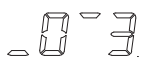

action 3,
relay contact is CLOSED over HIGHpoint, OPEN under LOWpoint, hysteresis between points

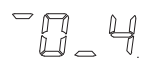

action 4,
relay contact is OPEN over HIGHpoint, CLOSED under LOWpoint, hysteresis between points



ACTIONS	under LOW	between LOW & HIGH	over HIGH
0 : 0.0.0	Open	Open	Open
1 : 0.I.0	Open	Closed	Open
2 : I.0.I	Closed	Open	Closed
3 : 0.X.I	Open	Hysteresis	Closed
4 : I.X.0	Closed	Hysteresis	Open

0 : Relay contact is OPEN

I : Relay contact is CLOSED

X: Relay Contact is at HYSTERESIS position, OPEN if previous position open, CLOSED if previous position closed

Modbus RS485 protocol

Default Settings: Modbus ID:1, 9600, 8bit, None, 1. Register Table starts from Base 1.

Use Function 3 for Reading and Function 6 for Writing Holding Registers. Whenever writing to any Modbus Parameter, the new parameter is activated instantly and you should have to configure the master device according to new parameters. For every reboot/initializing, Modbus is activated with default parameters for 3 seconds. After 3 seconds, Modbus is reconfigured according to your parameter settings.

Unlisted registers are for analog output calibrations and some system parameters. Please do not change unlisted registers.

Register	R/W	Range	Description
1	R & W	1...254	Modbus Address
2	R & W	0...2	Baudrate, 0: 9.600, 1: 19.200
3	R & W	0...3	Bit_Parity_Stop, 0: 8bit_None_1, 1: 8bit_None_2, 2: 8bit_Even_1, 3: 8bit_Odd_1
4	R		CO2 level as ppm
5	R		Temperature as C x100, divide by 100 for exact value
6	R	0 or 1	Relay 1, contact position, 0: OFF - Contact is Open, 1: ON - Contact is Closed
7	R	0...1.000	Relay 1, LOW point
8	R	0...1.000	Relay 1, HIGH point
9	R	0...4	Relay 1, ACTION
10	R	0 or 1	Relay 2, contact position, 0: OFF - Contact is Open, 1: ON - Contact is Closed
11	R	0...1.000	Relay 2, LOW point
12	R	0...1.000	Relay 2, HIGH point
13	R	0...4	Relay 2, ACTION
14	R	0 or 1	Buzzer, 0: OK-Silence, 1: PreAlarm - warning intermittently, 2: WARNING continuously
15	R	0...1.000	Buzzer, LOW point
16	R	0...1.000	Buzzer, HIGH point
17	R	0...4	Buzzer, ACTION
18-29	R		Only for service needs
30	R		CO2 level as ppm
31	R		Temperature as C x100, divide by 100 for exact value
32	R		Temperature as C
33	R		Temperature as F x100, divide by 100 for exact value
34	R		Temperature as F
35	R		Humidity as %rH x100, divide by 100 for exact value
36	R		Humidity as %rH



■ Dimensions (mm)

