

## Room air quality sensor

# KSAV



### Description

The KSAV probe for mixed gases (VOC) measures air quality in the range 0...500. It can be supplied with a 0...10 V DC or 4...20 mA output and with an SPST-NO relay.

### Technical specifications

<b>Measurement range VOC</b>	0...500
<b>Accuracy VOC</b>	±15% FS
<b>Power supply</b>	24 V AC (±5%), 50-60 Hz, 15...35 V DC
<b>Consumption</b>	<2,5 W
<b>Relay</b>	SPST-NO potential free
<b>Relay contact</b>	Max 1 A a 230 V AC
<b>Electrical connection</b>	Screw terminal for cables max. 1,5 mm <sup>2</sup>
<b>Housing</b>	ABS (plastic) colour white
<b>Weight</b>	ca. 96 g
<b>Protection type</b>	IP41
<b>Working range RH</b>	0...90% RH in contaminant-free, non-condensing air
<b>Working temperature</b>	-10...+50°C
<b>Standards</b>	CE conformity, RoHS







### Order matrix

Model	Output 1 CO <sub>2</sub>	Output 2 Temperature	Output 3 Humidity	Option
<b>KSIC</b>	<b>0</b> no output	<b>0</b> no output	<b>0</b> no output	<b>M</b> Modbus
	<b>1</b> 0...10 V	<b>1</b> 0...10 V	<b>1</b> 0...10 V	<b>D</b> Display
	<b>2</b> 2...10 V	<b>2</b> 2...10 V	<b>2</b> 2...10 V	<b>R</b> Relay 1
	<b>3</b> 0...5 V	<b>3</b> 0...5 V	<b>3</b> 0...5 V	<b>RR</b> Relay 2
	<b>4</b> 1...5 V	<b>4</b> 1...5 V	<b>4</b> 1...5 V	<b>B</b> Buzzer
	<b>5</b> 4...20 mA	<b>5</b> 4...20 mA	<b>5</b> 4...20 mA	

Relay and buzzer options are available only with display.

### DIP Switch

DIP 1-2	Range
	0...500
	0...400
	0...300
	0...200





## Transmitter hardware

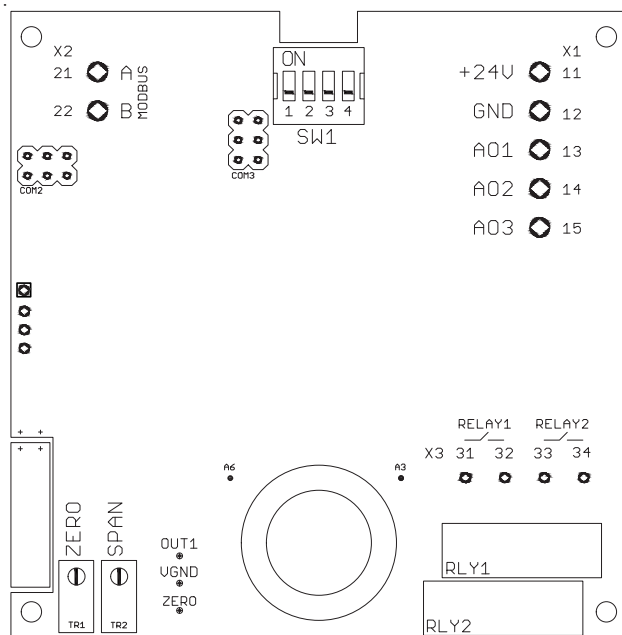

SW1 DIP Switch for configuration range and response time

### X1 TERMINAL

11	24V	15...35 VDC or 24 VAC ( $\pm$ %5, 50-60 Hz)
12	GND	ground for power and reference for outputs
13	AO1	analog output 1
14	AO2	analog output 2
15	AO3	analog output 3

### X2 TERMINAL

21	A / RS485	modbus communication positive pair
22	B / RS485	modbus communication negative pair

RLY1 & RLY2 relay 1 and relay 2

### X3 TERMINAL

31	NO - RL1	relay 1 dry contact max. rating 1 A @ 230 V AC
32	NO - RL1	relay 1 dry contact max. rating 1 A @ 230 V AC
33	NO - RL2	relay 2 dry contact max. rating 1 A @ 230 V AC
34	NO - RL2	relay 2 dry contact max. rating 1 A @ 230 V AC

## Electrical wirings

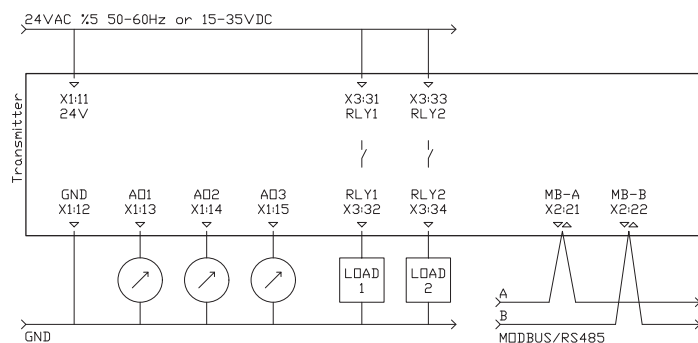

Relay contact rating is max. 1 A at 230 V AC

We kindly advise using 24 V AC for avoiding high voltage harmonics and external power relay for bigger loads. Please use shielded and twisted paired cables for Modbus connections.



## Display

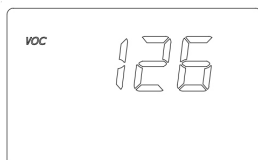
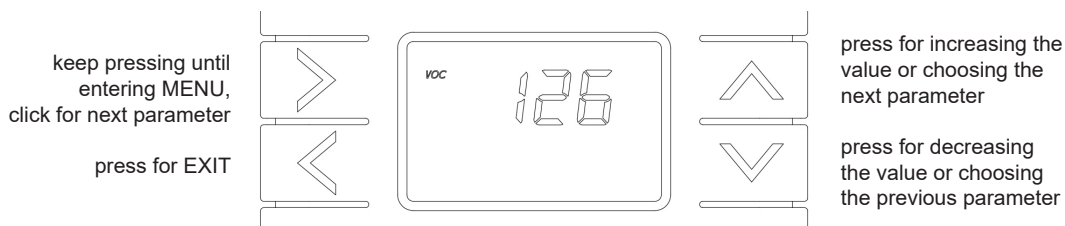

main screen  
transmitter is working



keep pressing MENU button until seeing SET  
transmitter is not working in MENU mode

## Parameters for relay and buzzer

Main Screen >>>> r1 L > r1 H > r1 A > r2 L > r2 H > r2 A > B L > B H > B A > Main Screen

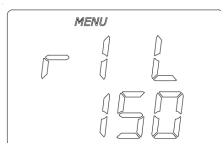

LOW set point  
for relay 1

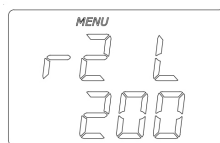

LOW set point  
for relay 2

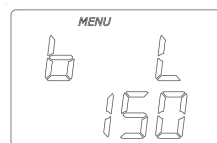

LOW set point  
for buzzer

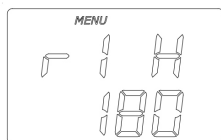

HIGH set point  
for relay 1

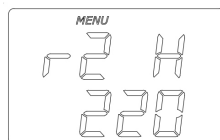

HIGH set point  
for relay 2

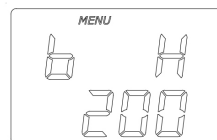

HIGH set point  
for buzzer

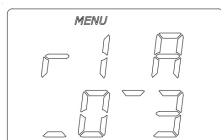

ACTION selection  
for relay 1

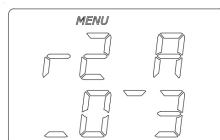

ACTION selection  
for relay 2

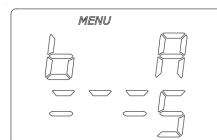

ACTION selection  
for buzzer



## Actions for Relay & Buzzer



Action 0, valid for relays and buzzer,  
relay contact is always OPEN  
buzzer is always SILENCE



Action 1, valid for relays and buzzer,  
relay contact is CLOSED between points, OPEN under LOWpoint and OPEN over HIGHpoint  
buzzer is WARNING between points, SILENCE under LOWpoint and SILENCE over HIGHpoint



Action 2, valid for relays and buzzer,  
relay contact is OPEN between points, CLOSED under LOWpoint and OPEN over HIGHpoint  
buzzer is SILENCE between points, WARNING under LOWpoint and SILENCE over HIGHpoint



Action 3, valid for relays and buzzer,  
relay contact is CLOSED over HIGHpoint, OPEN under LOWpoint, hysteresis between points  
buzzer is WARNING over HIGHpoint, SILENCE under LOWpoint, hysteresis between points

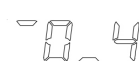

Action 4, valid for relays and buzzer,  
relay contact is OPEN over HIGHpoint, CLOSED under LOWpoint, hysteresis between points  
buzzer is SILENCE over HIGHpoint, WARNING under LOWpoint, hysteresis between points



Action 5, valid only for buzzer,  
buzzer is WARNING over HIGHpoint, SILENCE under LOWpoint,  
buzzer is WARNING intermittently between points,



Action 6, valid only for buzzer,  
buzzer is WARNING under LOWpoint, SILENCE over HIGHpoint,  
buzzer is WARNING intermittently between points,



Action 7, valid only for buzzer,  
buzzer is following relay 1 contact,  
buzzer is WARNING when relay 1 contact is CLOSED, SILENCE when the contact is OPEN



Action 8, valid only for buzzer,  
buzzer is following relay 2 contact,  
buzzer is WARNING when relay 2 contact is CLOSED, SILENCE when the contact is OPEN

AZIONI	sotto LOW	fra LOW e HIGH	sopra HIGH
0 : 0.0.0	Open / Silence	Open / Silence	Open / Silence
1 : 0.1.0	Open / Silence	Closed / Warning	Open / Silence
2 : 1.0.1	Closed / Warning	Open / Silence	Closed / Warning
3 : 0.X.1	Open / Silence	Hysteresis	Closed / Warning
4 : 1.X.0	Closed / Warning	Hysteresis	Open / Silence
5 : 0.-.1	Silence	Pre Alarm	Warning
6 : 1.-.0	Warning	Pre Alarm	Silence
7 : = r1	Silence when RL1 is Open, Warning when RL1 is Closed		
8 : = r2	Silence when RL2 is Open, Warning when RL2 is Closed		

0 : Relay Contact is OPEN, Buzzer is in Silent mode

1 : Relay Contact is CLOSED, Buzzer is in Warning mode

X : Relay Contact is at HYSTERESIS position, OPEN if previous position open, CLOSED if previous position closed

: Buzzer is in HYSTERESIS mode, Silent if previous mode is silent, Warning if previous mode is warning

- : Buzzer is in PRE ALARM mode, Buzzer is warning intermittently



## ■ Modbus RS485 protocol

Default Settings: Modbus ID:1, 9600, 8bit, None, 1. Register Table starts from Base 1.

Use Function 3 for Reading and Function 6 for Writing Holding Registers. Whenever writing to any Modbus Parameter, a new parameter is activated instantly and you should have to configure the master device according to the new parameters. For every reboot/initializing, Modbus is activated with default parameters for 3 seconds. After 3 seconds, Modbus is reconfigured according to your parameter settings. Unlisted registers are for analog output calibrations and some system parameters. Please do not change unlisted registers.

ID 254 is the general address. The transmitter replies to address 254 regardless of its own ID. Please use one master and one slave for checking the Modbus address. Also, baudrate and other parameters should match.

Register	R/W	Range	Description
1	R & W	1...254	Modbus Address
2	R & W	0...4	Baudrate, 0: 9.600, 1: 19.200
3	R & W	0...3	Bit_Parity_Stop, 0: 8bit_None_1, 1: 8bit_None_2, 2: 8bit_Even_1, 3: 8bit_Odd_1
4	R	0...500	VOC Index
5	R	0...65.536	VOC Raw Signal
6	R	0 or 1	Relay 1, contact position, 0: OFF - Contact is Open, 1: ON - Contact is Closed
7	R	0...1.000	Relay 1, LOW point
8	R	0...1.000	Relay 1, HIGH point
9	R	0...4	Relay 1, ACTION
10	R	0 or 1	Relay 2, contact position, 0: OFF - Contact is Open, 1: ON - Contact is Closed
11	R	0...1.000	Relay 2, LOW point
12	R	0...1.000	Relay 2, HIGH point
13	R	0...4	Relay 2, ACTION
14	R	0 or 1	Buzzer, 0: OK-Silence, 1: PreAlarm - warning intermittently, 2: WARNING continuously
15	R	0...1.000	Buzzer, LOW point
16	R	0...1.000	Buzzer, HIGH point
17	R	0...4	Buzzer, ACTION

## ■ Indoor Air Quality Index & PM2.5

The value 100 refers to the average indoor gas composition over the past 24 h. While values between 100 and 500 indicate a deterioration, values between up to 100 inform about improvement of the air quality. The Gas Index Algorithm is updated every second.

## ■ Dimensioni (mm)

without relay

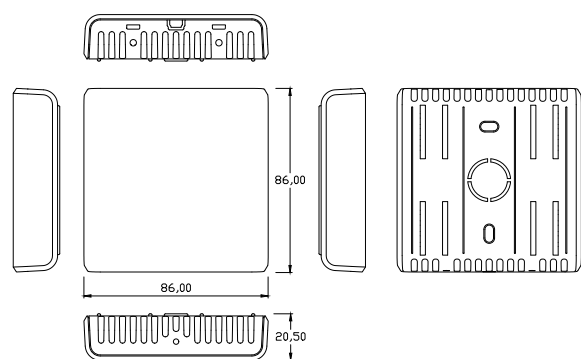

with relay

